

Article number: 0102225

Description: Retaining ring J470 DIN472  
Spring steel

## Measures

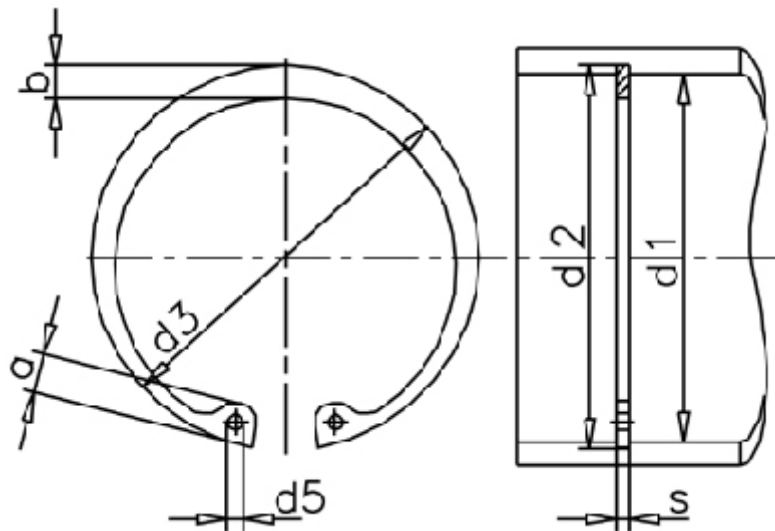

a max	=	FN kN	= 1495.00	t	= 6.00
AN mm <sup>2</sup>	= 8973.0	FRg kN	= 132.0	tol	= +1,00
b	= 26.0	FR kN	= 1330.0	tol	= +2,00-1,00
d1	= 470	g	= 6.0	tol	= -0.15
d2	= 482.0	K kN-mm	= 3048.0	Tong	= ZGJ-5
d3	= 490.00	m min	= 7.20	Weight kg/1000	= 1595.00
d5 min	= 6.0	Nominal drive	= 18.0		
Description = J 470		s	= 7.00		